

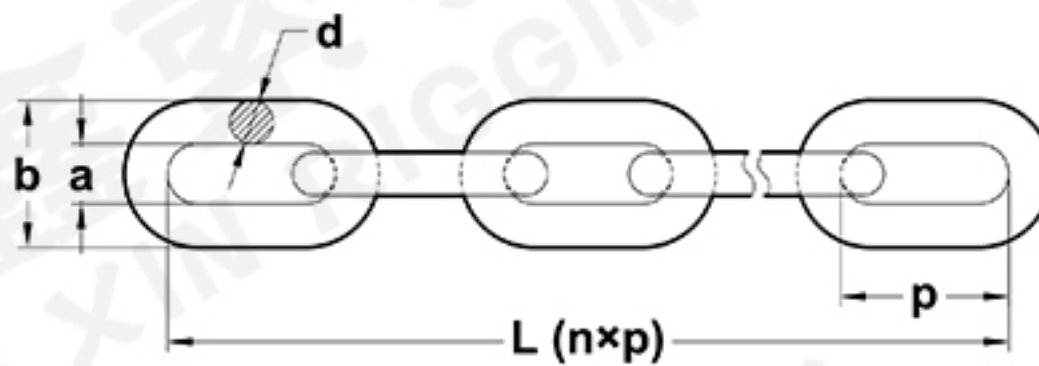

YXR1600



**TRAWL CHAIN (SHORT LINK)**

ITEM NO.	SIZE d x p MM	WIDTH (MM)		WEIGHT KG/M	BREAKING LOAD MIN. KN
		INSIDE MIN. a	INSIDE MIN. b		
YXR1600-01	7 x 21	10	25.5	1.05	60
YXR1600-02	10 x 30	14	36	2.2	125
YXR1600-03	13 x 39	18.1	47.1	3.8	214
YXR1600-04	16 x 48	22.4	57.4	5.63	320
YXR1600-05	19 x 57	27.8	68.8	7.81	450
YXR1600-06	20 x 60	29	72	8.52	500



YXR1601

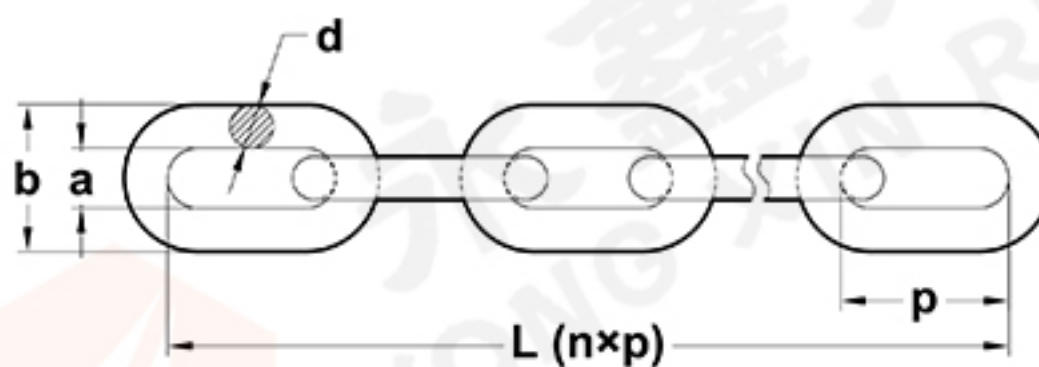

**TRAWL CHAIN (MID LINK)**

ITEM NO.	SIZE d x p MM	WIDTH (MM)		WEIGHT KG/M	BREAKING LOAD MIN. KN
		INSIDE MIN. a	INSIDE MIN. b		
YXR1601-01	13 x 52	19.5	48.5	3.31	214
YXR1601-02	16 x 64	24	59	4.97	320
YXR1601-03	19 x 76	28.5	69.5	6.92	450
YXR1601-04	22 x 86	27	74	9.5	610
YXR1601-05	26 x 92	31	86	13.7	850



YXR1602

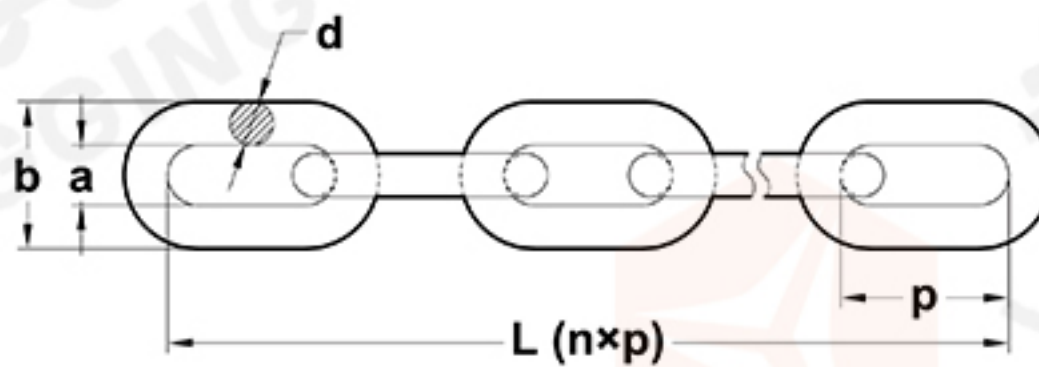

**TRAWL CHAIN (LONG LINK)**

ITEM NO.	SIZE d X p MM	WIDTH (MM)		WEIGHT KG/M	BREAKING LOAD MIN. KN
		INSIDE MIN. a	INSIDE MIN. b		
YXR1602-01	11 x 63	18	43	2.16	152
YXR1602-02	13 x 80	22	51	2.93	214
YXR1602-03	16 x 100	26	61	4.34	320
YXR1602-04	19 x 100	27	68	6.31	450
YXR1602-05	22 x 100	37	84	8.74	610

### LIFTING CHAIN / HOIST CHAIN

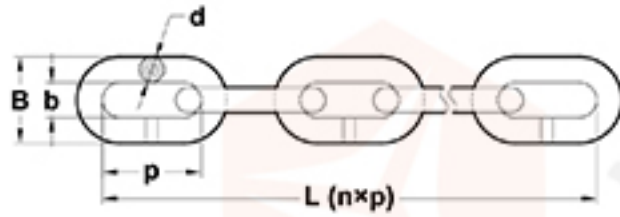

YXR1603

ITEM NO.	SIZE d × p (MM)	WEIGHT (KG)/M	INSIDE LENGTH P	MIN INSIDE WIDTH b	MAX OUTSIDE WIDTH B	WORKING LOAD LIMIT (KN)	TEST LOAD (KN)	BREAKING LOAD (KN)
YXR1603-01	6 × 18	0.79	18	7.5	21	11	27	45.2
YXR1603-02	7 × 21	1.07	21	9	24.5	15	37	61.6
YXR1603-03	8 × 24	1.38	24	10	28	20	48	80.4
YXR1603-04	9 × 27	1.9	27	11.5	30	24.5	61	102
YXR1603-05	10 × 30	2.2	30	12.5	35	32	76	125
YXR1603-06	12 × 36	3.3	36	15.5	42.2	49	117	196
YXR1603-07	13 × 39	3.8	39	16.3	46	50	128	214
YXR1603-08	14 × 42	4.13	42	18	49	63	150	250
YXR1603-09	16 × 48	5.63	48	20	56	80	192	320
YXR1603-10	18 × 54	6.85	54	23	63	100	246	410
YXR1603-11	20 × 60	8.6	60	25	70	125	300	500
YXR1603-12	22 × 66	10.5	66	28	77	153	366	610
YXR1603-13	24 × 72	12.78	72	32	82	180	432	720
YXR1603-14	26 × 78	14.87	78	35	91	213	510	650
YXR1603-15	30 × 90	19.6	90	38	105	283	678	1130
YXR1603-16	32 × 96	22.29	96	40	106	322	772	1289
YXR1603-17	34 × 102	25.5	102	46.5	121.5	363	870	1450
YXR1603-18	36 × 108	31	108	49.5	128.5	407	978	1630
YXR1603-19	38 × 114	32	114	52	136	453	1086	1810
YXR1603-20	42 × 126	38.6	126	55.5	144.5	554	1332	2200

### HIGH TEST CHAIN FOR MINING

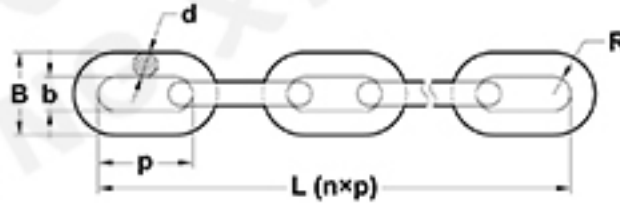

YXR1604

ITEM NO.	SIZE d × p (MM)	DIAMETER d	INSIDE LENGTH p	CIRCLE RADIUS R	MIN INSIDE WIDTH b	MAX OUTSIDE WIDTH B	TEST LOAD (KN)	BREAKING LOAD (KN)	GRADE
YXR1604-01	10 × 40	10 ± 0.4	40 ± 0.5	15	12	34	85	110	B
YXR1604-02	14 × 50	14 ± 0.4	50 ± 0.5	22	17	48	150	190	B
YXR1604-03	18 × 64	18 ± 0.4	64 ± 0.6	28	21	60	260	320	B
YXR1604-04	22 × 86	22 ± 0.5	86 ± 0.9	34	26	74	380	480	B
YXR1604-05	26 × 92	26 ± 0.8	92 ± 0.9	40	30	86	540	670	B
YXR1604-06	30 × 108	30 ± 0.9	108 ± 1.0	46	34	98	710	890	B
YXR1604-07	34 × 126	34 ± 1.0	126 ± 1.2	52	38	109	900	1130	C
YXR1604-08	38 × 137	38 ± 1.1	137 ± 1.4	28	42	123	1450	1810	C
YXR1604-09	42 × 146	42 ± 1.3	146 ± 1.5	64	42	110	1770	2220	C
YXR1604-10	48 × 152	48 ± 1.5	152 ± 1.5	78	46	135	1850	2900	C
YXR1604-11					46	115			
YXR1604-12					62	163			
YXR1604-13					56	127			



YXR1605

LASHING CHAIN

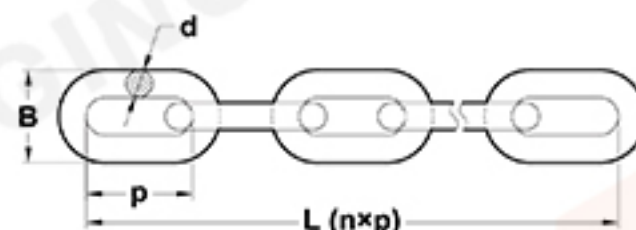

ITEM NO.	SIZE D (MM)	WEIGHT (KG/M)	INSIDE LENGTH P	OUTSIDE WIDTH B	PROOF LOAD (KN)	BREAKING LOAD (KN)
YXR1605-01	9	1.42	53	33	49	98
YXR1605-02	10(A)	1.75	65	42	63	125
YXR1605-03	10(B)	1.8	53	35	63	125
YXR1605-04	11	2.18	64	40	73.5	147
YXR1605-05	12	2.58	64	42	73.58	147
YXR1605-06	13(A)	3.05	82	54.6	95	190
YXR1605-07	13(B)	3.01	80	48	95	190
YXR1605-08	14	3.55	80	50	100	200
YXR1605-09	16	4.58	96	57	136	273
YXR1605-10	19	7.64	100	67.2	160	320



YXR1606

THREE LINK CHIAN FOR MINING

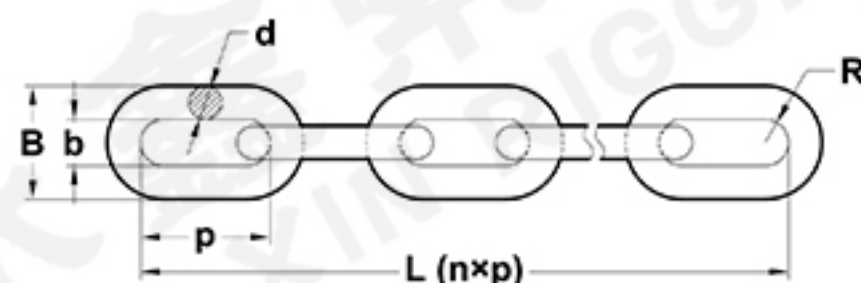

ITEM NO.	SIZE d x p (MM)	DIAMETER d	INSIDE LENGTH p	CIRCLE RADIUS R	MIN INSIDE WIDTH b	MAX OUTSIDE WIDTH B	TEST LOAD (KN)	BREAKING LOAD (KN)	WEIGHT (KG/M)
YXR1606-01	22 x 105	22	105	41	40	87	70	370	2.9
YXR1606-02	26 x 118	26	118	48	46	102	100	520	4.6
YXR1606-03	28 x 120	28	120	51	48	108	110	610	6.7
YXR1606-04	30 x 120	30	120	53	48	112	120	670	7.8
YXR1606-05	30 x 130	30	130	56.5	55	119	120	670	6.9
YXR1606-06	32 x 140	32	140	60	58	126	140	790	9.9
YXR1606-07	34 x 147	34	147	65	64	136	160	890	10.1
YXR1606-08	38 x 145	38	145	77	80	160	200	1110	13.65



YXR1607

BOOM CHAIN

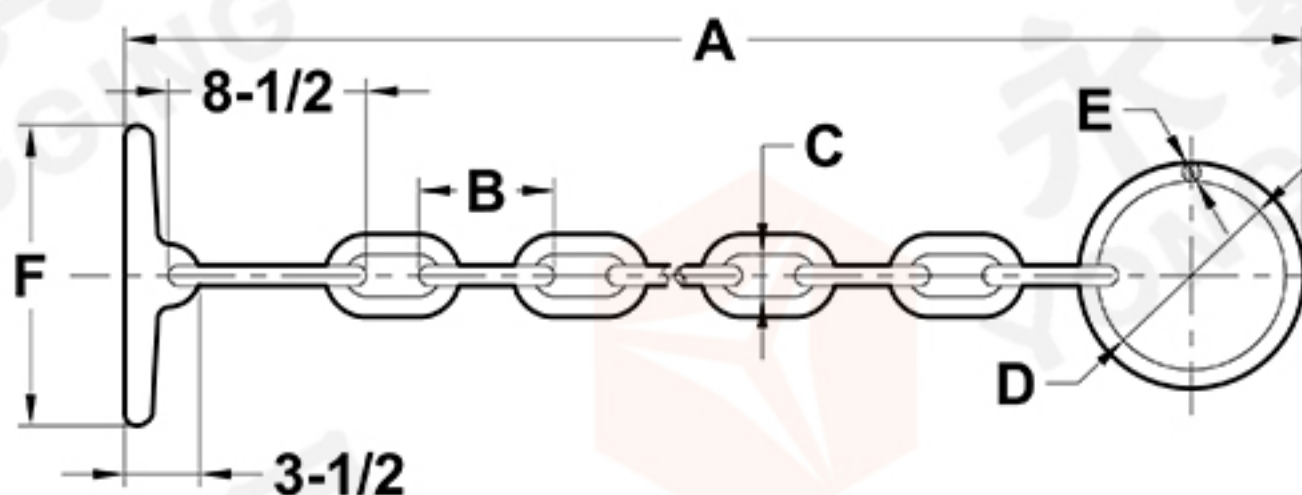

ITEM NO.	NORMINAL SIZE (IN.)	WEIGHT (KG)	AVERAGE MINIMUM BEAKING STRENGTH (LBS)	DIMENSIONS (IN.)					
				A(ft)	B	C	D	E	F
YXR1607-01	3/4	37	50000	7	4-1/2	2-5/8	5-1/2	1	12
YXR1607-02	7/8	53	70000	7	5-1/4	3-1/8	6	1-1/8	12
YXR1607-03	1	65	90000	7	6	3-1/2	8	1-1/8	12



YXR1608

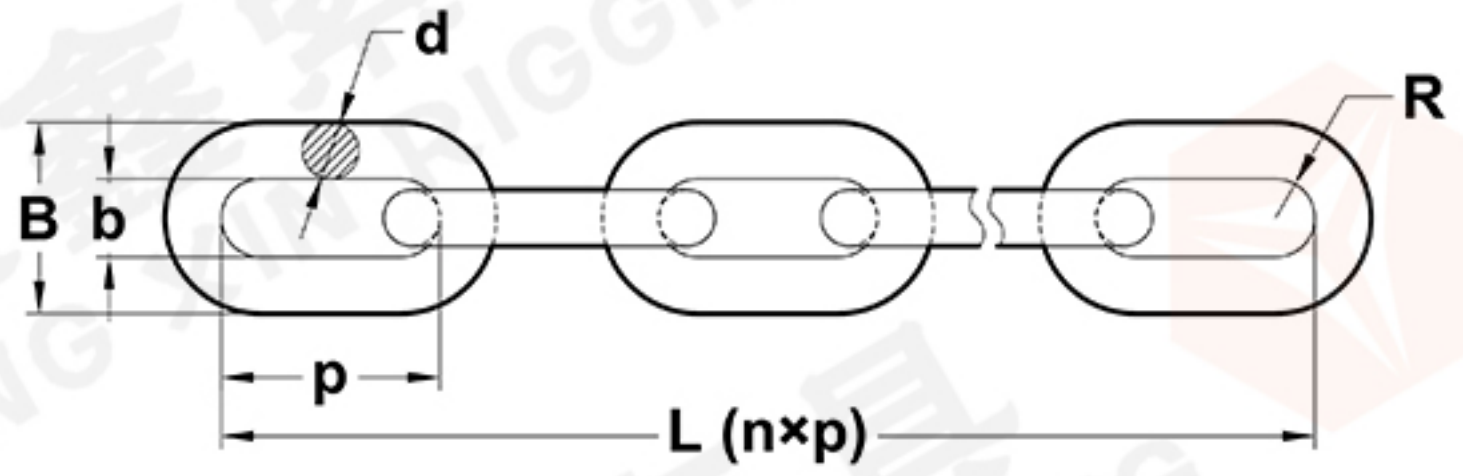

### FISHING CHAIN

ITEM NO.	KINDS OF CHAIN	SIZE d × p (MM)	WIDTH (MM)		WEIGHT (KG/M)	BREAKING LOAD (KN)	
			INSIDE WIDTH b	OUTSIDE WIDTH B			
YXR1608-01	Short Link Chain	7 × 21	10	25.5	1.05	60	
YXR1608-02		10 × 30	14	36	2.2	125	
YXR1608-03		13 × 39	18.1	47.1	3.8	214	
YXR1608-04		16 × 48	22.4	57.4	5.63	320	
YXR1608-05		19 × 59	27.8	68.8	7.81	450	
YXR1608-06		20 × 60	29	72	8.52	500	
YXR1608-07	Mid Link Chain	10 × 40	15	37	1.9	125	
YXR1608-08		13 × 52	19.5	48.5	3.31	214	
YXR1608-09		14 × 50	18.5	49.5	4	250	
YXR1608-10		16 × 64	24	59	4.97	320	
YXR1608-11		19 × 76	28.5	69.5	6.92	450	
YXR1608-12		22 × 86	27	74	9.5	610	
YXR1608-13		26 × 92	31	86	13.7	850	
YXR1608-14		Long Link Chain	7 × 45	10	25.5	0.82	60
YXR1608-15			9 × 53	15	35	1.36	100
YXR1608-16			11 × 63	18	43	2.16	152
YXR1608-17			13 × 80	22	51	2.93	214
YXR1608-18			16 × 100	26	61	4.34	320
YXR1608-19			19 × 100	27	68	6.31	450
YXR1608-20			22 × 120	37	84	8.94	610
YXR1608-21			28 × 150	44	103	14.41	980

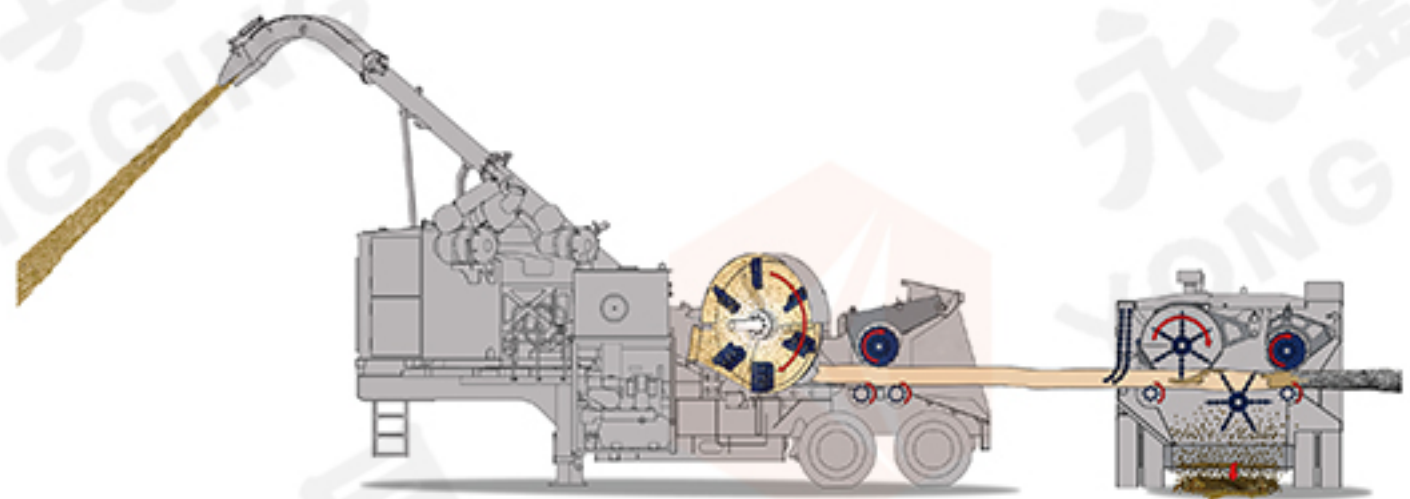
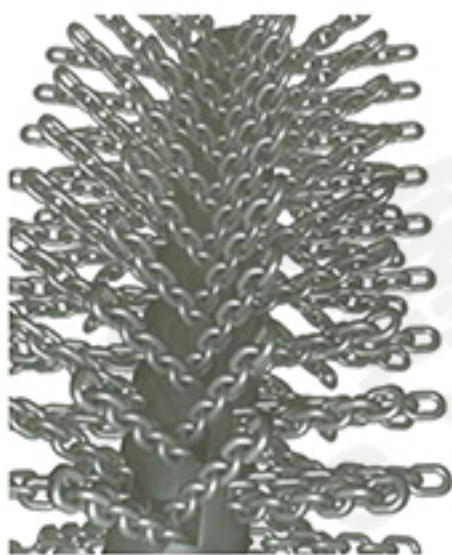

YXR1609

### DEBARKING CHAIN

ITEM NO.	NUMBER OF LINKS	MATERIAL DIAMETER (IN.)	INSIDE LINKS DIMENSIONS (IN.)	WORKING LENGTH (IN.)	PIECES /DRUM	WEIGHT /DRUM (LBS.)
YXR1609-01	8	0.63	0.95 × 1.68	14.07	250	1158
YXR1609-02	9	0.63	0.95 × 1.68	15.75	200	1034
YXR1609-03	10	0.63	0.95 × 1.68	17.43	150	1155

### HATCH BOARD CHAIN



YXR1610

ITEM NO.	SIZE d (MM)	WEIGHT (KG/M)	INSIDE LENGTH p	OUTSIDE WIDTH B	PROOF LOAD (KN)	BREAKING LOAD (KN)
YXR1610-01	11	2.39	43	12.5	57	116
YXR1610-02	14(A)		50	19	97	
YXR1610-03	14(B)		42	19	106	
YXR1610-04	15		55	22	128	254
YXR1610-05	16(A)		55	22	128	254
YXR1610-06	16(B)		55	22	128	254
YXR1610-07	18(A)	7.12	54	54	161	322
YXR1610-08	18(B)	6.32	64	64	161	322
YXR1610-09	19	7.6	57	57	164	330
YXR1610-10	20(A)	9.5	60	60	129	359
YXR1610-11	20(B)	8.57	62	62	179	359
YXR1610-12	22(A)	9.86	78	78	240	480
YXR1610-13	22(B)	9.24	86	86	240	480
YXR1610-14	22(C)	10.6	66	66	240	480
YXR1610-15	30	18.22	108	108	399	798

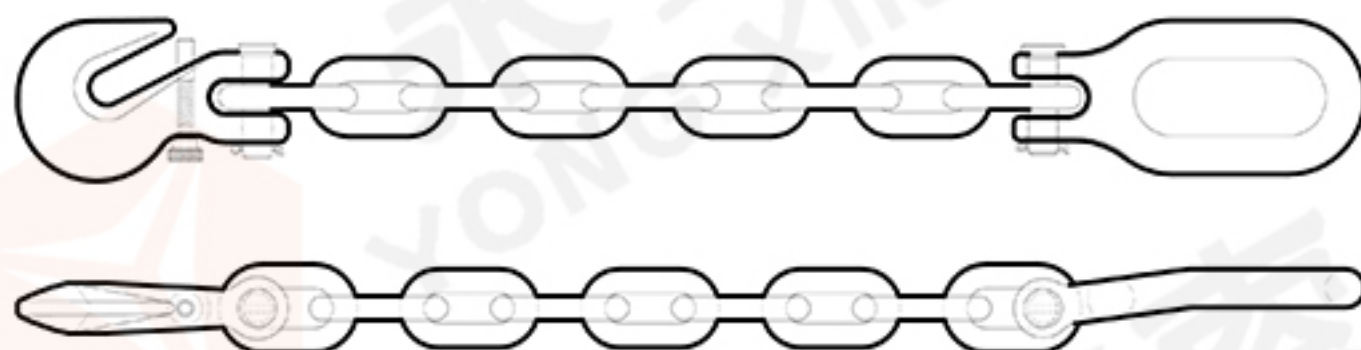

YXR1611

### CHAIN WITH GRAB HOOK AND CLEVIS PEAR LINK

ITEM NO.	SIZE (IN.)	WEIGHT (KG)	DIMENSIONS (MM)							
			A	B	C	D	E	F	G	H
YXR1611-01	5/16	13	12	32	55	43	59.5	128.5	12	12
YXR1611-02	3/8	16	16	39	56	55	83	154	16	14



YXR1612

### CHAIN RETAINER

ITEM NO.	SIZE (IN.)	MBS (LBS)	WT (KG)	DIMENSIONS (MM)						
				A	B	C	D	E	H	L
YXR1612-01	5/16	10000	0.30	33	12.5	22.5	15	17.5	81	96
YXR1612-02	3/8	25000	0.45	40	15	25.5	15	19	91	105.5

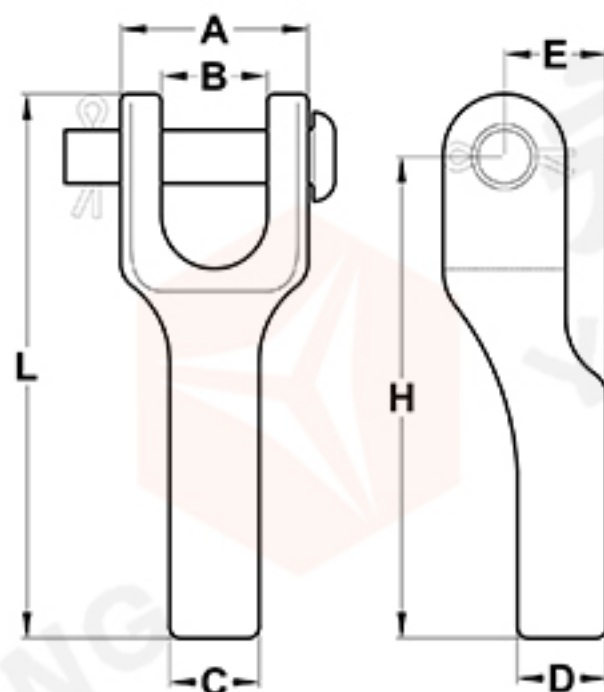

CHAIN WITH CLEVIS / EYE GRAB HOOKS ON BOTH END

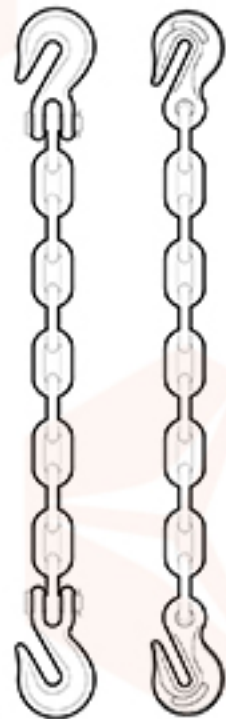

YXR1613

ITEM NO.	SIZE (IN.)	ASTM1980			NACM1990			NACM1996/2010			PC/ DRUM
		WT (KG)	WL (LBS)	BL (LBS)	WT (KG)	WL (LBS)	BL (LBS)	WT (KG)	WL (LBS)	BL (LBS)	
GRADE 43											
YXR1613-01	1/4 × 14FT	5.0	2600	7750	4.5	2600	7500	4.5	2600	7800	50
YXR1613-02	1/4 × 16FT	6.0	2600	7750	5.0	2600	7500	5.0	2600	7800	40
YXR1613-03	5/16 × 14FT	7.5	3900	11600	6.0	3900	9700	7.0	3900	11700	35
YXR1613-04	5/16 × 16FT	8.5	3900	11600	6.5	3900	9700	8.0	3900	11700	30
YXR1613-05	5/16 × 18FT	9.5	3900	11600	7.5	3900	9700	9.0	3900	11700	30
YXR1613-06	5/16 × 20FT	10.5	3900	11600	8.0	3900	9700	9.5	3900	11700	25
YXR1613-07	5/16 × 25FT	13.0	3900	11600	10.0	3900	9700	12.0	3900	11700	20
YXR1613-08	5/16 × 30FT	15.5	3900	11600	12.0	3900	9700	14.0	3900	11700	20
YXR1613-09	3/8 × 14FT	10.5	5400	16200	9.5	5400	15200	10.0	5400	16200	25
YXR1613-10	3/8 × 16FT	12.0	5400	16200	11.0	5400	15200	11.5	5400	16200	25
YXR1613-11	3/8 × 20FT	15.0	5400	16200	13.5	5400	15200	13.5	5400	16200	20
YXR1613-12	3/8 × 25FT	18.5	5400	16200	16.5	5400	15200	17.5	5400	16200	15
YXR1613-13	3/8 × 30FT	27.0	9200	27600	23.5	9200	25700	24.7	9200	27600	10
GRADE 70											
YXR1613-14	1/4 × 14FT	5.0	3150	12600	4.5	3150	12100	4.0	3150	12600	50
YXR1613-15	1/4 × 16FT	6.0	3150	12600	5.0	3150	12100	5.0	3150	12600	40
YXR1613-16	5/16 × 14FT	7.5	4700	18800	6.0	4700	18800	7.0	4700	18800	35
YXR1613-17	5/16 × 16FT	8.5	4700	18800	6.5	4700	18800	8.0	4700	18800	30
YXR1613-18	5/16 × 18FT	9.5	4700	18800	7.5	4700	18800	9.0	4700	18800	30
YXR1613-19	5/16 × 20FT	10.5	4700	18800	8.0	4700	18800	10.0	4700	18800	25
YXR1613-20	5/16 × 25FT	13.0	4700	18800	10.0	4700	18800	12.0	4700	18800	20
YXR1613-21	5/16 × 30FT	15.5	4700	18800	12.0	4700	18800	14.5	4700	18800	20
YXR1613-22	3/8 × 14FT	10.5	6600	26400	9.5	6600	24700	10.0	6600	26400	25
YXR1613-23	3/8 × 16FT	12.0	6600	26400	11.0	6600	24700	11.5	6600	26400	20
YXR1613-24	3/8 × 20FT	15.0	6600	26400	13.5	6600	24700	14.5	6600	26400	20
YXR1613-25	3/8 × 25FT	18.5	6600	26400	16.5	6600	24700	18.0	6600	26400	15
YXR1613-26	1/2 × 20FT	26.0	11300	45200	23	11300	45200	24.5	11300	45200	10
YXR1613-27	1/2 × 25FT	32.5	11300	45200	28	11300	41800	30	11300	45200	8

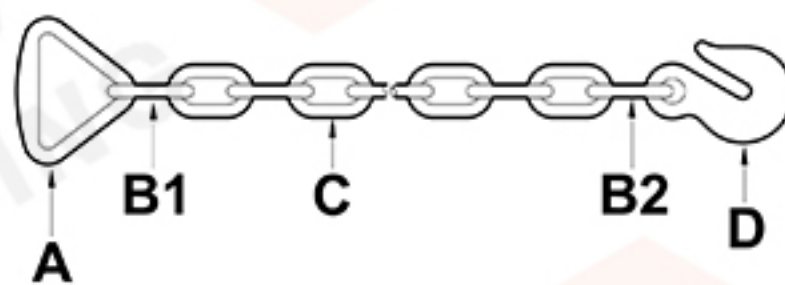

CHAIN WITH DELTA RING AND HOOK EACH ONE END



YXR1614

ITEM NO.	A (IN)	B1 (IN)	C (IN)	B2 (IN)	D (IN)	LENGTH (IN)	WEIGHT (KG)	BREAKING LOAD (LBS)	PC/ BAG
YXR1614-01	2	3/8	5/16 × 11L	3/8	5/16	18	1.17	10000	50
YXR1614-02	2	3/8	5/16 × 11L	3/8	3/8	18	1.17	10000	50
YXR1614-03	3	7/16	5/16 × 10L	7/16	5/16	18	1.32	16200	35
YXR1614-04	3	7/16	3/8 × 9L	7/16	3/8	18	1.48	16200	35
YXR1614-05	3	7/16	3/8 × 5L	7/16	3/8	12	1.28	16200	35
YXR1614-06	4	7/16	3/8 × 9L	7/16	3/8	18	1.68	20000	35
YXR1614-07	*	3/8	5/16 × 11L	3/8	5/16	18	1.30	11000	35
YXR1614-08	*	7/16	3/8 × 9L	7/16	3/8	18	1.35	16200	35

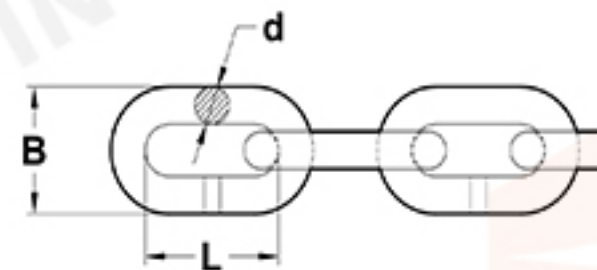

### DIN763 LINK CHAIN



YXR1615

ITEM NO.	SIZE (D)		INSIDE LENGTH (L)		OUTSIDE WIDTH (B)		WORK LIMITED LOAD	PROOF LOAD	BREAKING LOAD	KG/M
	mm	±mm	mm	±mm	mm	±mm				
YXR1615-01	mm	±mm	mm	±mm	mm	±mm	kg	N	N	kg
YXR1615-02	2		22	1.0	8	0.4	25	800	1250	0.06
YXR1615-03	2.5		24	1.1	10	0.5	40	800	2000	0.10
YXR1615-04	3		26	1.2	12	0.6	55	1050	3200	0.15
YXR1615-05	3.5		28	1.3	14	0.7	80	1540	3850	0.20
YXR1615-06	4	0.5	32	1.5	16	0.8	100	2000	6000	0.27
YXR1615-07	4.5		34	1.7	18	0.9	128	2500	6300	0.35
YXR1615-08	5		35	1.8	20	1.0	160	3150	10000	0.43
YXR1615-09	5.5		38.5	1.8	22	1.1	195	3800	9500	0.52
YXR1615-10	6		42	2.0	24	1.2	224	4500	14000	0.63
YXR1615-11	7		49	2.5	28	1.4	300	6000	18000	0.86
YXR1615-12	8		52	2.5	32	1.6	400	8000	25000	1.10
YXR1615-13	8.5		56	2.8	34	1.7	460	9000	22500	1.25
YXR1615-14	9		59	3.0	36	1.8	530	10500	32000	1.41
YXR1615-15	10		65	3.2	40	2.0	630	12500	40000	1.75
YXR1615-16	11		72	3.4	44	2.0	790	15800	47500	2.11
YXR1615-17	12		78	3.6	48	2.3	940	18800	56500	2.55
YXR1615-18	13		82	4.0	52	2.5	1000	21200	63000	2.95
YXR1615-19	16	1	100	5.0	64	3.2	1600	33000	100000	4.45
YXR1615-20	18		113	5.2	70	3.2	2120	42300	127000	5.65
YXR1615-21	19		119	5.6	72	3.4	2370	47300	142000	6.25
YXR1615-22	20		120	6.0	75	3.8	2500	50000	160000	7.00
YXR1615-23	22		127	6.0	82	4.0	3170	63300	190000	8.55
YXR1615-24	25		140	6.6	85	4.2	4090	81700	245000	10.90
YXR1615-25	28		152	7.0	96	4.7	6000	120000	300000	13.90
YXR1615-26	32		171	7.8	108	5.2	8000	160000	400000	18.20

### DIN764 LINK CHAIN

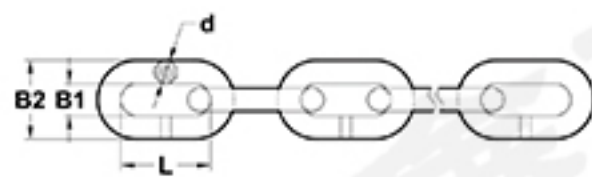

YXR1616

ITEM NO.	SIZE (d)		INSIDE LENGTH (L)		INSIDE WIDTH (B1)		OUTSIDE WIDTH (B2)		LENGTH PER 11 LINKS		WEIGHT PER 100 M	BREAKING LOAD	PROOF LOAD
	mm	±mm	mm	±mm	mm	mm	mm	mm	mm	±mm			
YXR1616-01	mm	±mm	mm	±mm	mm	mm	mm	mm	mm	±mm	kg	KN	kg
YXR1616-02	4	0.2	16	0.3	0.2	5	14	176	1.6	0.9	31.3	7	400
YXR1616-03	5	0.2	18	0.4	0.2	7	18.2	198	1.8	1.0	51.4	11.8	680
YXR1616-04	6	0.2	21	0.5	0.2	8	21.5	231	2.0	1.1	74	16.5	850
YXR1616-05	8	0.2	28	0.5	0.3	11	29	308	2.2	1.2	131.5	32	1680
YXR1616-06	10	0.3	35	0.6	0.3	14	36	385	2.7	1.5	200	50	2630
YXR1616-07	12	0.3	42	0.6	0.3	16	41	462	3.2	1.8	298	70	3680
YXR1616-08	13	0.4	45	0.7	0.4	18	47	495	3.5	2.0	350	80	4200
YXR1616-09	14	0.45	49	0.75	0.45	20	48	539	3.8	2.0	406	92	4830
YXR1616-10	16	0.5	56	0.9	0.5	22	58	616	4.3	2.5	520	125	6700
YXR1616-11	18	0.8	63	1.0	0.5	24	65	693	4.7	2.8	650	160	8400
YXR1616-12	20	1.0	70	1.1	0.6	27	72	770	5.4	3.2	820	200	10000
YXR1616-13	23	1.2	80	1.3	0.7	31	83	880	6.2	3.5	1100	250	13000
YXR1616-14	26	1.3	91	1.5	0.8	35	94	1001	7.0	4.0	1400	320	16000



YXR1617

USA STANDARD CHAIN WITH S HOOKS

ITEM NO.	SIZE (IN.)	ASTM80			NACM90			NACM96		
		WT (KG)	WL (LBS.)	BL (LBS.)	WT (KG)	WL (LBS.)	BL (LBS.)	WT (KG)	WL (LBS.)	BL (LBS.)
YXR1617-01	3/16 × 48	0.8	800	3200	0.8	800	3200	0.8	800	3200
YXR1617-02	1/4 × 48	1.5	1330	5300	1.4	1300	5200	1.4	1300	5200
YXR1617-03	5/16 × 48	2.2	2000	8000	1.9	1900	6800	2.2	1900	7600

ENGLISH STANDARD ORDINARY LINK CHAIN (SHORT LINK)

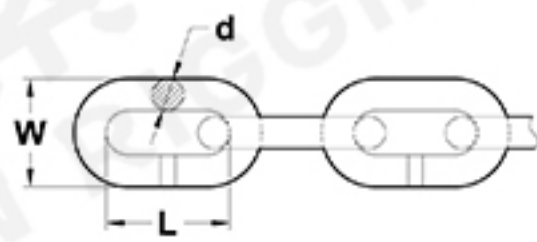

YXR1618

ITEM NO.	LINK SPECIFICATION				PROOF LOAD	BREAKING LOAD	NET WT PER 200 FT (KG)	
	DIAMETER (D)	INSIDE LENGTH (L)	OUTSIDE WIDTH (W)				B.F.	H.D.G.
YXR1618-01	Inch	±mm	mm	mm	kg	kg	B.F.	H.D.G.
YXR1618-02	1/8	3.20	16	12	200	400	11.4	11.7
YXR1618-03	5/32	4.00	18.5	14.5	300	600	18.6	19.0
YXR1618-04	3/16	4.70	19	17	400	800	26.2	27.0
YXR1618-05	7/32	5.50	20	19	550	1100	36.8	38.0
YXR1618-06	1/4	6.35	22	21	750	1500	50.0	51.5
YXR1618-07	5/16	7.94	26	26	1200	2400	80.0	82.4
YXR1618-08	3/8	9.50	28	32	1700	3400	122.0	125.7
YXR1618-09	7/16	11.11	33	36	2300	4600	164.0	169.0
YXR1618-10	1/2	12.70	39	43	3000	6000	210.0	216.0
YXR1618-11	5/8	15.80	45	53	4700	9400	334.0	344.0
YXR1618-12	3/4	19.00	55	63	6800	13600	485.0	499.0
YXR1618-13	7/8	22.20	64	74	9250	18500	656.0	675.0
YXR1618-14	1	25.40	73	84	12150	24300	870.0	896.0

ENGLISH STANDARD ORDINARY LINK CHAIN (LONG LINK)

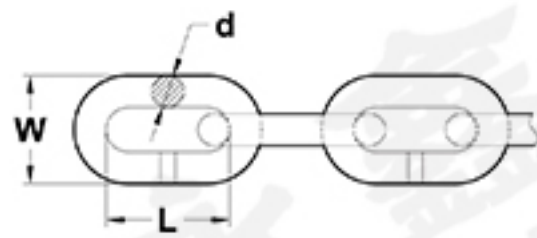

YXR1619

ITEM NO.	LINK SPECIFICATION				PROOF LOAD	BREAKING LOAD	NET WT PER 200 FT (KG)	
	DIAMETER (D)	INSIDE LENGTH (L)	OUTSIDE WIDTH (W)				B.F.	H.D.G.
YXR1619-01	Inch	±mm	mm	mm	kg	kg	B.F.	H.D.G.
YXR1619-02	1/8	3.20	23	12	200	400	10.4	10.7
YXR1619-03	5/32	4.00	27	15	300	600	16.6	17.5
YXR1619-04	3/16	4.70	31	17	400	800	22.4	23.3
YXR1619-05	7/32	5.50	32	19	550	1100	32.0	33.0
YXR1619-06	1/4	6.35	33	21	750	1500	43.5	44.8
YXR1619-07	5/16	7.94	48	31	1200	2400	68.0	70.0
YXR1619-08	3/8	9.50	60	37	1700	3400	96.0	99.0
YXR1619-09	7/16	11.11	71	41	2300	4600	126.0	129.0
YXR1619-10	1/2	12.70	85	48.5	3000	6000	167.0	172.0
YXR1619-11	5/8	15.80	114	61.5	4700	9400	256.0	264.0
YXR1619-12	3/4	19.00	125	75	6800	13600	381.0	392.0
YXR1619-13	7/8	22.20	140	88	9250	18500	527.0	543.0
YXR1619-14	1	25.40	155	100	12150	24300	696.0	716.0



### TOW CHAIN

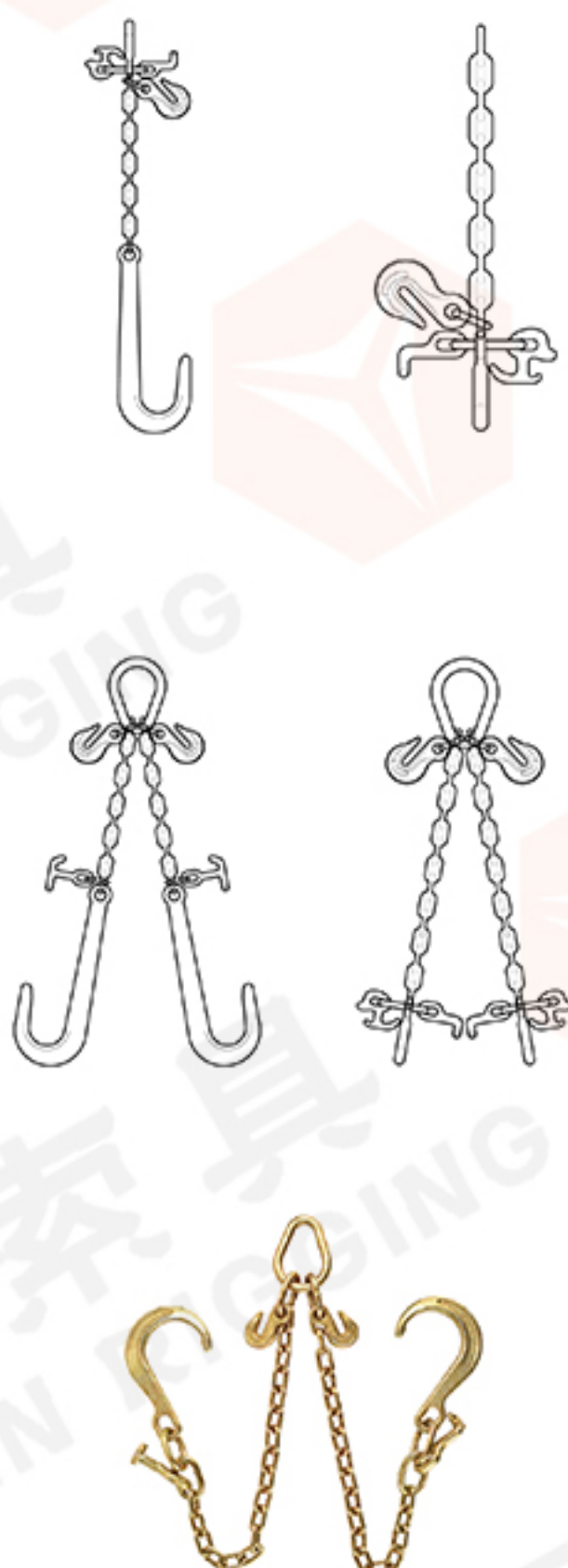

YXR1620

ITEM NO.	SIZE (IN.)	ASTM1980			NACM1990			NACM1996/2010			PC/ DRUM
		WT (KG)	WL (LBS)	BL (LBS)	WT (KG)	WL (LBS)	BL (LBS)	WT (KG)	WL (LBS)	BL (LBS)	
GRADE 43											
YXR1620-01	1/4 × 14FT	5.0	2600	7750	4.5	2600	7500	4.5	2600	7800	50
YXR1620-02	1/4 × 16FT	6.0	2600	7750	5.0	2600	7500	5.0	2600	7800	40
YXR1620-03	5/16 × 14FT	7.5	3900	11600	6.0	3900	9700	7.0	3900	11700	35
YXR1620-04	5/16 × 16FT	8.5	3900	11600	6.5	3900	9700	8.0	3900	11700	30
YXR1620-05	5/16 × 18FT	9.5	3900	11600	7.5	3900	9700	9.0	3900	11700	30
YXR1620-06	5/16 × 20FT	10.5	3900	11600	8.0	3900	9700	9.5	3900	11700	25
YXR1620-07	5/16 × 25FT	13.0	3900	11600	10.0	3900	9700	12.0	3900	11700	20
YXR1620-08	5/16 × 30FT	15.5	3900	11600	12.0	3900	9700	14.0	3900	11700	20
YXR1620-09	3/8 × 14FT	10.5	5400	16200	9.5	5400	15200	10.0	5400	16200	25
YXR1620-10	3/8 × 16FT	12.0	5400	16200	11.0	5400	15200	11.5	5400	16200	25
YXR1620-11	3/8 × 20FT	15.0	5400	16200	13.5	5400	15200	13.5	5400	16200	20
YXR1620-12	3/8 × 25FT	18.5	5400	16200	16.5	5400	15200	17.5	5400	16200	15
YXR1620-13	3/8 × 30FT	27.0	9200	27600	23.5	9200	25700	24.7	9200	27600	10
GRADE 70											
YXR1620-14	1/4 × 14FT	5.0	3150	12600	4.5	3150	12100	4.0	3150	12600	50
YXR1620-15	1/4 × 16FT	6.0	3150	12600	5.0	3150	12100	5.0	3150	12600	40
YXR1620-16	5/16 × 14FT	7.5	4700	18800	6.0	4700	18800	7.0	4700	18800	35
YXR1620-17	5/16 × 16FT	8.5	4700	18800	6.5	4700	18800	8.0	4700	18800	30
YXR1620-18	5/16 × 18FT	9.5	4700	18800	7.5	4700	18800	9.0	4700	18800	30
YXR1620-19	5/16 × 20FT	10.5	4700	18800	8.0	4700	18800	10.0	4700	18800	25
YXR1620-20	5/16 × 25FT	13.0	4700	18800	10.0	4700	18800	12.0	4700	18800	20
YXR1620-21	5/16 × 30FT	15.5	4700	18800	12.0	4700	18800	14.5	4700	18800	20
YXR1620-22	3/8 × 14FT	10.5	6600	26400	9.5	6600	24700	10.0	6600	26400	25
YXR1620-23	3/8 × 16FT	12.0	6600	26400	11.0	6600	24700	11.5	6600	26400	20
YXR1620-24	3/8 × 20FT	15.0	6600	26400	13.5	6600	24700	14.5	6600	26400	20
YXR1620-25	3/8 × 25FT	18.5	6600	26400	16.5	6600	24700	18.0	6600	26400	15
YXR1620-26	1/2 × 20FT	26.0	11300	45200	23	11300	45200	24.5	11300	45200	10
YXR1620-27	1/2 × 25FT	32.5	11300	45200	28	11300	41800	30	11300	45200	8



YXR1621

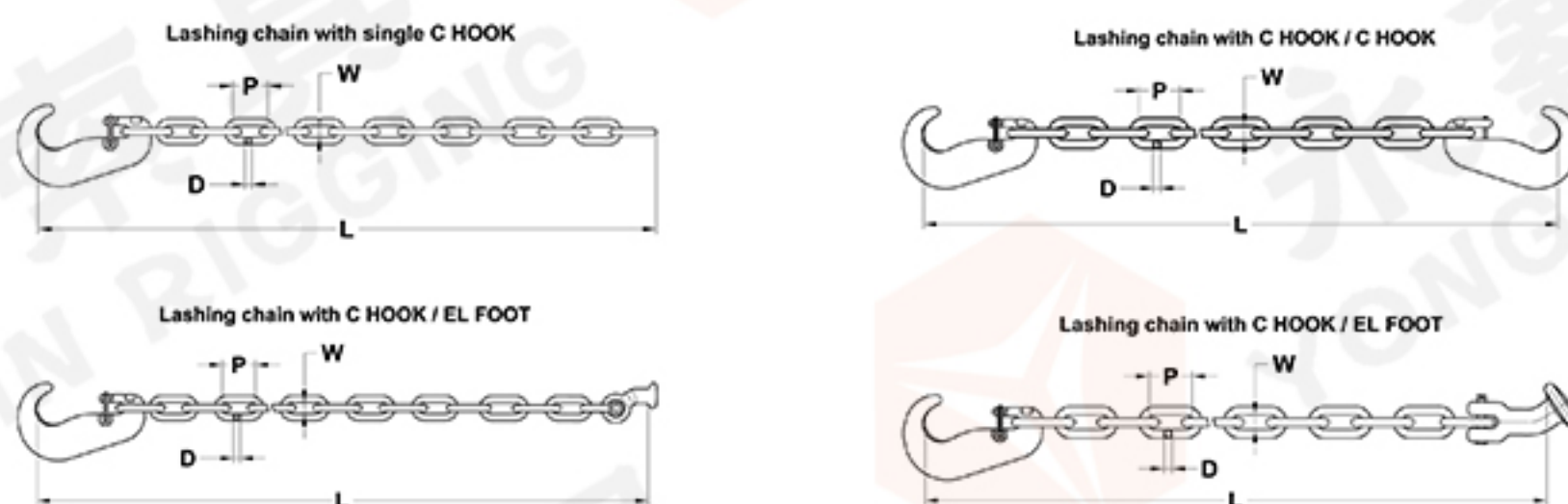

### CONTAINER LASHING CHAIN

ITEM NO.	DIA (MM)	P (MM)	W (MM)	B.L. (KN)	WEIGHT/M (KG)
YXR1621-01	13	80	22	200	3
YXR1621-02	11	65	20	150	2.2
YXR1621-03	9	56	15	100	1.6

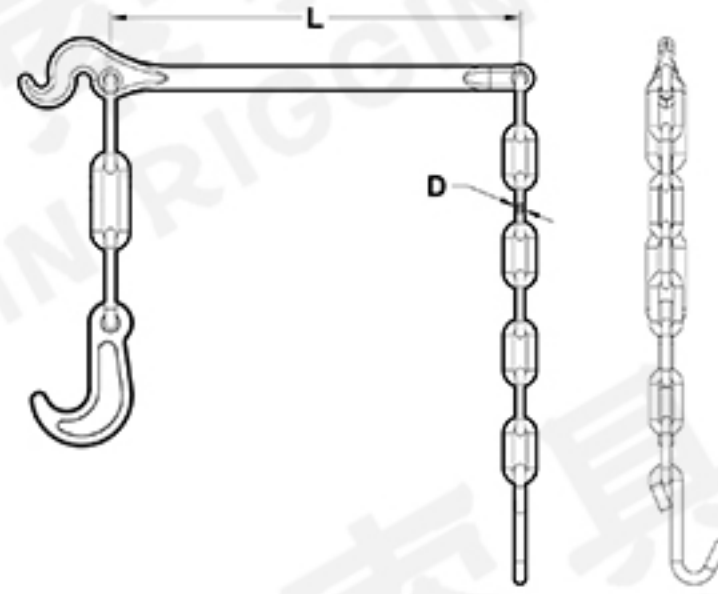

YXR1622

TENSION LEVER

ITEM NO.	DIA (MM)	L (MM)	D (MM)	B.L. (KN)	WEIGHT/M (KG)
YXR1622-01	13	485	14	200	6
YXR1622-02	11	496	13	150	4.5
YXR1622-03	9	480	12	100	4



YXR1623



G80 ONE LEG CHAIN SLING

ITEM NO.	CHAIN DIA (MM)	WLL (T)	MASTER LINK (MM)	WEIGHT /MTR (KG)	CHAIN WEIGHT (KG/M)
			AxBxD		
YXR1623-01	6	1.0	65x130x12	1.88	0.79
YXR1623-02	8	1.5	65x130x16	3.07	1.38
YXR1623-03	10	2.5	80x150x20	5.96	2.20
YXR1623-04	12	3.5	90x160x24	9.03	3.10
YXR1623-05	14	5.0	90x160x24	10.09	4.13
YXR1623-06	16	6.0	100x190x28	14.25	5.63



YXR1624

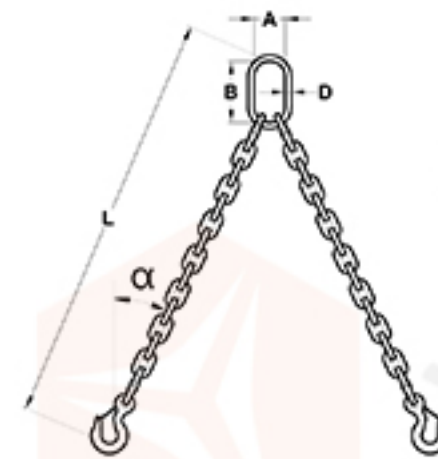

G80 TWO LEGS CHAIN SLING

ITEM NO.	CHAIN DIA (MM)	WLL (T)		MASTER LINK (MM)	WEIGHT /MTR (KG)	CHAIN WEIGHT (KG/M)
		$\alpha \leq 45^\circ$	$45^\circ < \alpha \leq 60^\circ$			
YXR1624-01	6	1.568	1.12	60x110x13	3.80	0.79
YXR1624-02	8	2.8	2.0	75x135x18	6.93	1.38
YXR1624-03	10	4.41	3.15	90x160x22	11.40	2.12
YXR1624-04	13	7.42	5.3	100x180x26	19.30	3.80
YXR1624-05	16	10.92	7.8	110x200x32	31.20	5.63



YXR1625

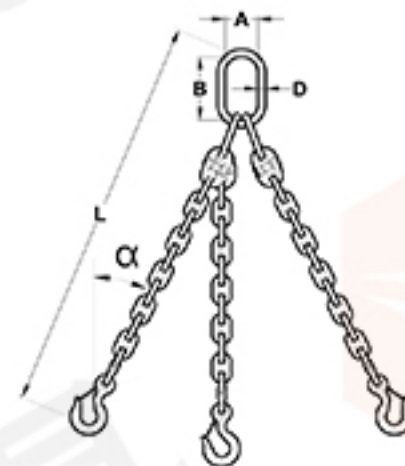

G80 THREE LEGS CHAIN SLING

ITEM NO.	CHAIN DIA (MM)	WLL (T)		MASTER LINK(MM) AxBxD	WEIGHT /MTR (KG)	CHAIN WEIGHT (KG/M)
		$\alpha \leq 45^\circ$	$45^\circ < \alpha \leq 60^\circ$			
YXR1625-01	6	2.1	1.5	80x150x20	5.79	0.79
YXR1625-02	8	3.1	2.2	90x160x24	9.66	1.38
YXR1625-03	10	5.2	3.7	100x190x28	18.47	2.20
YXR1625-04	12	7.3	5.2	100x190x28	26.34	3.10
YXR1625-05	14	10.5	7.5	120x230x34	32.04	4.13
YXR1625-06	16	12.6	9.0	135x250x38	41.66	5.63



YXR1626

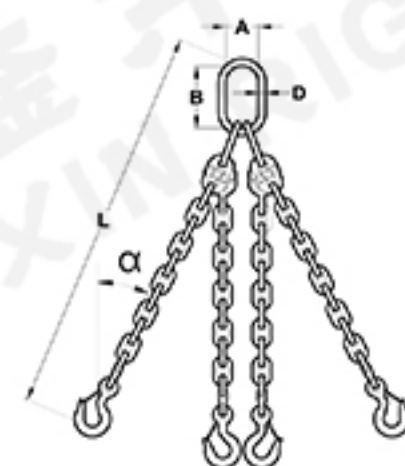

G80 FOUR LEGS CHAIN SLING

ITEM NO.	CHAIN DIA (MM)	WLL (T)		MASTER LINK(MM) AxBxD	WEIGHT /MTR (KG)	CHAIN WEIGHT (KG/M)
		$\alpha \leq 45^\circ$	$45^\circ < \alpha \leq 60^\circ$			
YXR1626-01	6	2.1	1.5	80x150x20	7.33	0.79
YXR1626-02	8	3.1	2.2	90x160x24	12.21	1.38
YXR1626-03	10	5.2	3.7	100x190x28	23.42	2.20
YXR1626-04	12	7.3	5.2	100x190x28	33.77	3.10
YXR1626-05	14	10.5	7.5	120x230x34	40.54	4.13
YXR1626-06	16	12.6	9.0	135x250x38	53.51	5.63



YXR1627

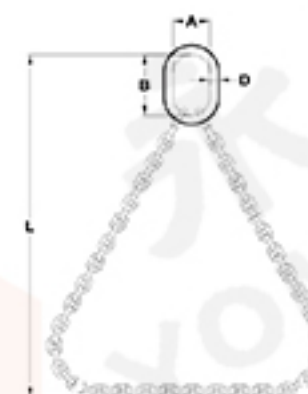

G80 ONE LEG CHOKER CHAIN SLING

ITEM NO.	CHAIN DIA (MM)	WLL (T)		MASTER LINK(MM) AxBxD	WEIGHT /MTR (KG)	CHAIN WEIGHT (KG/M)
		$\alpha \leq 45^\circ$	$45^\circ < \alpha \leq 60^\circ$			
YXR1627-01	6	1.12	0.8	65x130x16	1.50	0.79
YXR1627-02	8	1.68	1.2	65x130x16	2.25	1.38
YXR1627-03	10	2.80	2.0	80x150x20	3.98	2.20
YXR1627-04	12	3.92	2.8	90x160x24	5.98	3.10
YXR1627-05	14	5.60	4.0	100x190x28	8.75	4.13
YXR1627-06	16	6.72	4.8	100x190x28	11.13	5.63

EXAMPLE OF CHAIN SLINGS

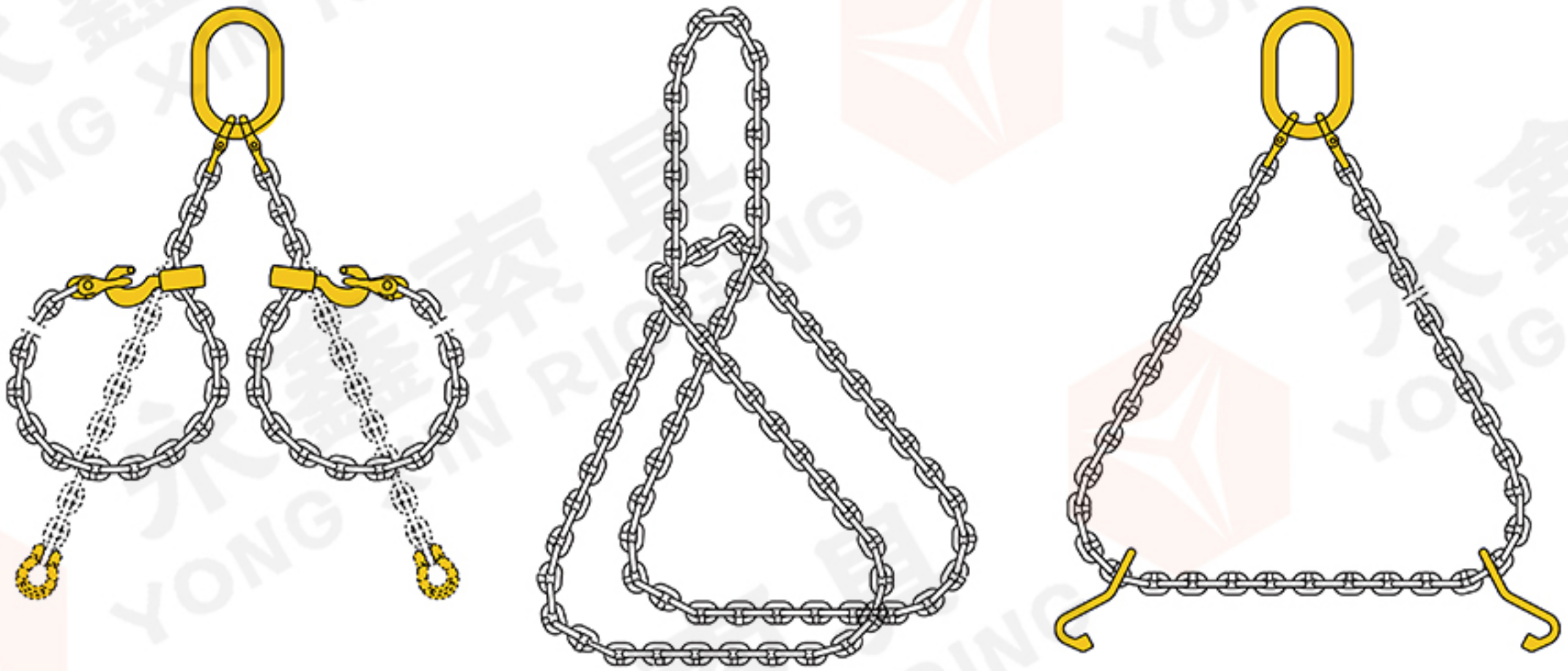

EXAMPLE OF WIRE ROPE SLING & WEB SLING

